

Varenummer: 0101236
 Beskrivelse: Seeger låsering A 580 DIN 471
 Fjederstål
 Note: Monteres med ZGA tang

Mål

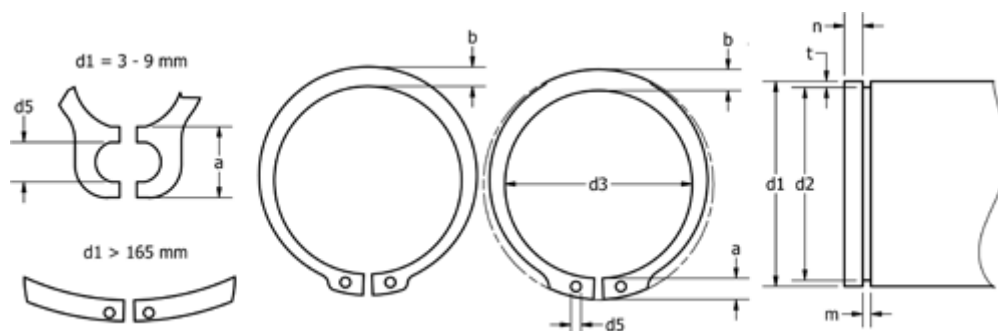

a max	= -	FN kN	= 2100.0	s	= 8.00
AN mm ²	= 12601.0	FRg kN	= 147.00	t	= 7.00
b	= 26.0	FR kN	= 1718.00	Tang	= ZGA-7
Betegnelse	= A580	g	= 7.0	tol	= -0.15
d1	= 580	K kN-mm	= 3936.00	tol	= +1,50-3,00
d2	= 566.0	m min	= 8.20	tol	= -1.00
d3	= 555.0	n abl x 1000	= 0.4	vægt kg/1000	= 999.999
d5 min	= 6.0	Nominel træk	= 21.0		